



Cutler-Hammer

Motor Control Center Type 11-300

Renewal Parts

Supersedes RP.03A.01A.S.E
pages 1-24, dated September 2000

Description

Motor Control Center Type 11-300 Unitrol

<i>Description</i>	<i>Page</i>
Distributor Ordering Instructions	2
Procedure for Identifying MCC Renewal Units and Parts	2
Identifying Motor Control Center Types	3
Procedure for Identifying Motor Control Center Types	4
11-300 Product Description	5
Replacement Starter Units	6 – 9
Unit Options	10 – 12
Structure Parts	13
Unit Parts	13
Replacement Feeder Units (All Vintages)	15

MCC Type	Dates	Cutler-Hammer Renewal Parts Publication
F2100 Advantage™ Series 2100	1995 – 1992 – 1987 – 95	RP04304001E RP04304002E RP04304003E
5 Star Freedom Unitrol F10 Unitrol	1975 – 87 1988 – 94 1972 – 89	RP04304003E RP04304004E RP04304005E
Type W 9800 Unitrol 11-300	1965 – 75 1956 – 74 1935 – 65	RP04304006E RP04304007E RP04304008E

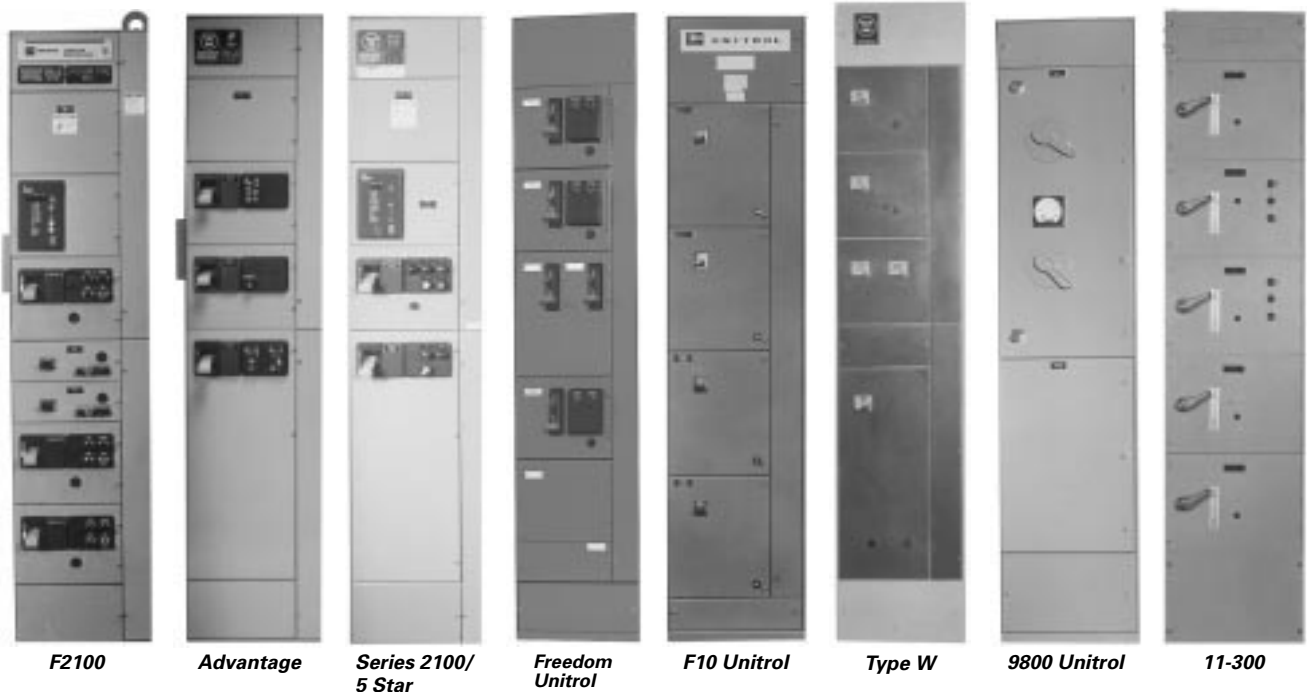

Distributor Ordering Instructions

1. Specify the item by catalog or style number.
2. For pricing information, refer to Price List PL04304002E (formerly PL 8991A dated November 1997).
3. Enter the order on VISTALINE™ on Suffix **FVU**, or through e-POD on Suffix **FVU**.
4. Selling Policy 25-000 (SP03000001E) applies, the Discount Symbol is **1CD-2C**.

Procedure for Identifying Motor Control Centers Renewal Units and Parts

1. Identify the design of the Eaton's Cutler-Hammer Motor Control Center (MCC) from the data found on the nameplate. Critical information includes:
 - Type of MCC.
 - Type of contactor.
 - Door width.
 - Bucket width.

Note: In the event that the nameplate is missing or unreadable, follow the procedure on **Page 4**.
2. Refer to **Pages 5 – 13** and turn to the section in this Renewal Parts to identify replacement units, options, structure parts, and unit parts for Type 11-300.
3. For Replacement Feeder Units, refer to **Page 15**.
4. This publication identifies those replacement units and parts which are most frequently ordered. Units should be ordered by complete catalog number, and parts by complete style number.

For parts not listed or shown, contact your authorized Cutler-Hammer distributor or local Cutler-Hammer sales representative.

5. If additional assistance is required, contact the Motor Control Center Aftermarket Product Center in Fayetteville, NC at **(910) 483-2222** or **1-800-OLD-UNIT** or Fax (910) 677-5208 or (910) 677-5272.

You can also contact one of our eight Service Centers for assistance with F2100, Advantage, Series 2100/5 Star, Freedom Unitrol, F10 Unitrol, Type W, 11-300 and 9800 Unitrol Motor Control Centers.

Atlanta

Phone (770) 739-6282
Fax (770) 739-7178

Chicago

Phone (847) 299-1911
Fax (847) 299-0398

Cincinnati

Phone (513) 682-4000
Fax (513) 682-4004

Denver

Phone (303) 373-2133
Fax (303) 375-9095

Hartford

Phone (860) 683-4221
Fax (860) 683-0764

Houston

Phone (713) 939-9696
Fax (713) 939-0427

Los Angeles

Phone (562) 944-6413
Fax (562) 941-7178

Portland

Phone (503) 636-8333
Fax (503) 636-8545

Identifying Motor Control Center Types

In most cases, it is possible to identify MCC design by handle type. Starter type, bucket width and door width can assist in identification.

Table 1. Identifying Motor Control Center Types

MCC Type	Type of Handle Mechanism	Original MCC Starter Type	Bucket Width Inches (mm)	Door Width Inches (mm)	Original Manufacturer ①	Starter Type (Installed in New Unit)
F2100 ②	Lever	Freedom Series	13-3/4 (349.3)	15-5/8 (397.0)	Cutler-Hammer 1994 to Present	Freedom
Advantage ②	Lever	Advantage	13-3/4 (349.3)	15-5/8 (397.0)	Westinghouse until 1994 Cutler-Hammer 1994 to Present	Advantage
Series 2100 ②	Lever	A200	13-3/4 (349.3)	15-5/8 (397.0)	Westinghouse until 1994 Cutler-Hammer 1994 to Present	A200
5 Star ②	Lever	A200	13-3/4 (349.3)	15-5/8 (397.0)	Westinghouse 1975 – 1987	A200
Freedom Unitrol	Slider	Freedom Series	13-7/8 (352.5)	15-1/2 (393.7)	Cutler-Hammer 1988 – 1994	Freedom
F10 Unitrol	Slider and Lever	Citation	14 (355.6)	14-3/4 (374.7) w/ Wireway 19-1/2 (495.3) w/o Wireway	Cutler-Hammer 1972 – 1989	Freedom
Type W	Slider	A200 or 11-200	11-3/4 (298.5)	13-3/8 (339.9)	Westinghouse 1965 – 1975	A200
9800 Unitrol	Rotary ③	3 Star/Citation	16-1/8 (409.7)	19-3/8 (492.3)	Cutler-Hammer 1956 – 1974	Freedom
11-300	Rotary	11-200 Lifeline Type N/A200	15-3/4 (400.1)	20 (508.0)	Westinghouse 1950 – 1965	A200

① MCC types were sometimes produced outside the time spans shown. This was due to the overlap of production when a new design was adopted.

② The unit “wrappers” are mechanically identical for these designs.

③ 9800 originally was supplied with Rotary. New replacement units are manufactured with slider handle mechanism.

Identification by Original Handle Mechanism



F2100, Advantage, Series 2100, 5 Star



Freedom Unitrol



*F10 Unitrol Slider
9800 Unitrol*



*F10 Unitrol Lever
9800 Unitrol*



Type W



9800 Unitrol

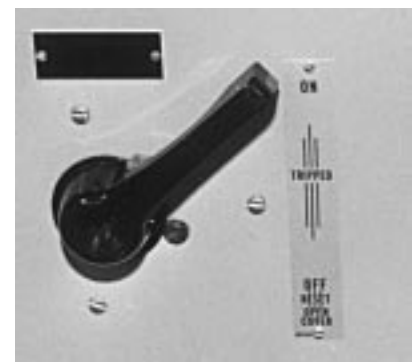

11-300

Procedure for Identifying Motor Control Center Types

In the event that the nameplate is missing, it is possible to identify the MCC design by the type of handle mechanism, starter type, bucket width and door width.

Table 2. Identifying Motor Control Center Types

MCC Type	Type of Handle Mechanism	Starter Type	Bucket Width Inches (mm)	Door Width Inches (mm)	Cutler-Hammer Renewal Parts Publication
F2100 Advantage Series 2100	Lever Lever Lever	Freedom Series Advantage A200	13-3/4 (349.3) 13-3/4 (349.3) 13-3/4 (349.3)	15-5/8 (397.0) 15-5/8 (397.0) 15-5/8 (397.0)	RP04304001E RP04304002E RP04304003E
5 Star Freedom Unitrol F10 Unitrol	Lever Slider Lever/Slider	A200 Freedom Series Citation	13-3/4 (349.3) 13-7/8 (352.5) 14 (355.6)	15-5/8 (397.0) 15-1/2 (393.7) 14-3/4 (374.7) w/ Wireway or 19-1/2 (495.3) w/o Wireway	RP04304003E RP04304004E RP04304005E
Type W 9800 Unitrol 11-300	Slider Rotary Rotary	A200 or 11-200 3 Star and/or Citation 11-200 Lifeline N and/or A200	11-3/4 (298.5) 16-1/8 (409.7) 15-3/4 (400.1)	13-3/8 (339.9) 19-3/8 (492.3) 20 (508.0)	RP04304006E RP04304007E RP04304008E



F2100

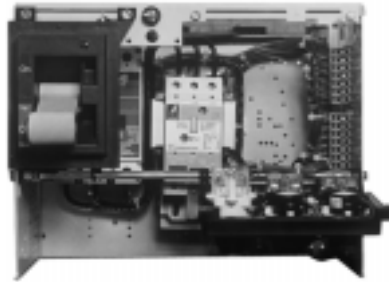

Advantage



Series 2100/5 Star

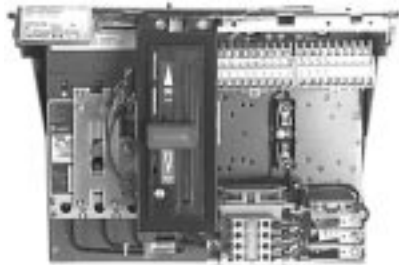

Freedom Unitrol

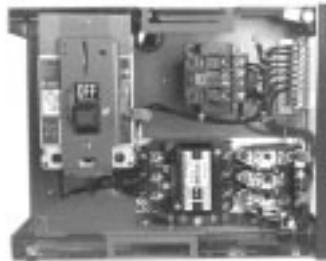

F10 Unitrol



Type W



9800 Unitrol



11-300

11-300 Product Description

Introduced in 1950, Westinghouse manufactured the 11-300 MCC through 1965 and it was available as match and line-up until 1974. It used standard structures each 20 inches (508.0 mm) wide, 90-3/8 (2295.7 mm) inches high and either 20-1/4 inches (514.4 mm) or 12 inches (304.8 mm) deep, for either front or back-to-back mounting. Vertical sections may be bolted together forming a single line-up with continuous horizontal bus and open horizontal wireways. Unit height was measured in either 9-1/3 inches (237.0 mm) or 14-inch (355.6 mm) increments up to a maximum of 70 inches (1778.0 mm) of usable vertical space.

ANSI 61 light gray enamel was used on all structural parts. The unit door was hinged on the right and covered the entire width of the structure.

The 11-300 starter unit was most easily recognized by the slide plate type of handle mechanism. Bus and support systems were typically braced to withstand fault currents of 25,000A.

Table 3. 11-300 Product Rating

Maximum Ratings
3-Phase, 600V, 100 hp, 1600A Bus



**11-300
Structure**



11-300 Starter Unit

11-300 Replacement Starter Units

How to Order

When ordering a replacement unit, you receive:

- Series C® HMCP.
- A200 Starter.
- Unit options as specified.
- New steel wrapper, door and handle mechanism.
- New stabs.
- UL® label.

Use the following steps for creating a catalog number for your specific application:

Step 1

Select the correct replacement unit from **Pages 6 – 9**. When selecting, you need to know the following:

- MCC type.
- Class of Unit (FVNR, FVR, Reduced Voltage — Autotransformer or Part Winding or Solid State, FV – 2 Speed, 1 Winding or 2 Speed, 2 Winding, etc.).
- Starter size or horsepower rating.
- Protection device (breaker or fusible).
- Service voltage.
- Control voltage.
- Space required.

Step 2

Verify required space is available.

Step 3

Create a catalog number by selecting Catalog Codes from the columns per the example given.

Step 4

Add modifications as required from the Unit Options on **Pages 10 – 12**. Space available determines allowable options.

Table 4. Catalog Numbering System Example

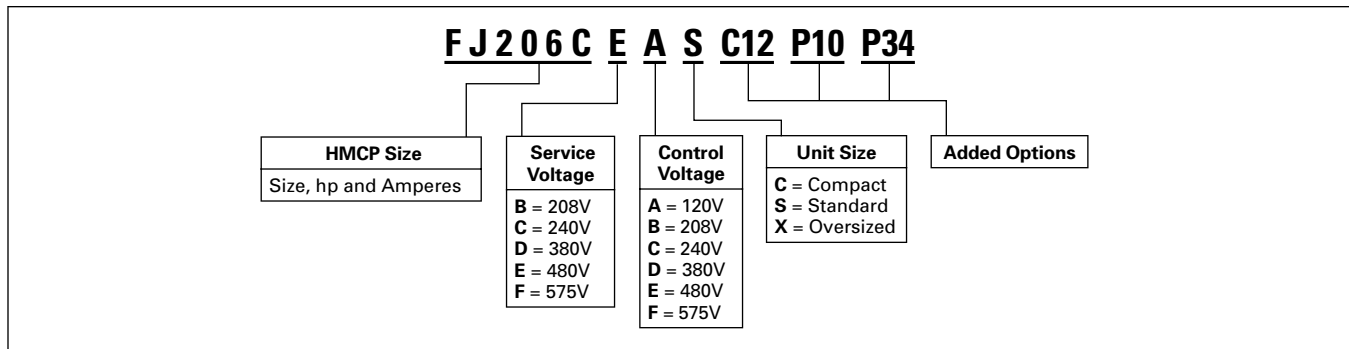

Table 5. Full Voltage Non-Reversing Combination Starter — HMCP

NEMA® Size	Maximum Horsepower					HMCP Size	Catalog Code	Service Voltage	Catalog Code	Control Voltage	Catalog Code	Space Options Inches (mm)	Catalog Code
	208V	240V	380V	480V	600V								
1	0.5 1 3 7.5	0.33 1 3 7.5	1 2 5 10	1 3 7.5 10	1.5 3 7.5 10	3 7 15 30	FJ206A FJ206B FJ206C FJ206D	208 240 380 480 575	B C D E F	120 208 240 380 480 575	A B C D E F	9 (228.6) High 14 (355.6) High 18-2/3 (474.1) High	C ^① S X
2	10	15	25	25	25	50	FJ206E	208 240 380 480 575	B C D E F	120 208 240 380 480 575	A B C D E F	14 (355.6) High 18-2/3 (474.1) High	S X
3	25	30	50	50	50	100	FJ206H	208 240 380 480 575	B C D E F	120 208 240 380 480 575	A B C D E F	18-2/3 (474.1) High	S
4	40	50	75	100	100	150	FJ206L	208 240 380 480 575	B C D E F	120 208 240 380 480 575	A B C D E F	28 (711.2) High	S
5	60 75	60 100	125 150	150 200	150 200	250 400	FJ206P FJ206R	208 240 380 480 575	B C D E F	120 208 240 380 480 575	A B C D E F	37-1/3 (948.3) High	S

① 3 pilots maximum.

11-300 Replacement Starter Units

Table 6. Full Voltage Reversing Combination Starter — HMCP

NEMA Size	Maximum Horsepower					HMCP Size	Catalog Code	Service Voltage	Catalog Code	Control Voltage	Catalog Code	Space Options Inches (mm)	Catalog Code
	208V	240V	380V	480V	600V								
1	0.5	0.33	1	1	1.5	3	FJ216A	208	B	120	A	18-2/3 (474.1) High 28 (711.2) High	S X
	1	1	2	3	3	7	FJ216B	240	C	208	B		
	3	3	5	7.5	7.5	15	FJ216C	380	D	240	C		
	7.5	7.5	10	10	10	30	FJ216D	480	E	380	D		
575						FJ216E	575	F	480	F			
10	15	25	25	25	50	FJ216E	208	B	120	A	28 (711.2) High	S	
							240	C	208	B			
							380	D	240	C			
							480	E	380	D			
							575	F	480	E			
									575	F			
25	30	50	50	50	100	FJ216H	208	B	120	A	28 (711.2) High	S	
							240	C	208	B			
							380	D	240	C			
							480	E	380	D			
							575	F	480	E			
									575	F			
40	50	75	100	100	150	FJ216L	208	B	120	A	28 (711.2) High 37-1/3 (948.3) High	S X	
							240	C	208	B			
							380	D	240	C			
							480	E	380	D			
							575	F	480	E			
									575	F			
50	60	100	125	150	250	FJ216P	208	B	120	A	56 (1422.4) High	S	
75	100	150	200	200	400	FJ216R	240	C	208	B			
							380	D	240	C			
							480	E	380	D			
							575	F	480	E			
									575	F			

Table 7. Full Voltage 2 Speed 1 Winding — Constant/Variable Torque — HMCP ①

NEMA Size	Maximum Horsepower					HMCP Size	Catalog Code	Service Voltage	Catalog Code	Control Voltage	Catalog Code	Space Options Inches (mm)	Catalog Code
	208V	240V	380V	480V	600V								
1	0.5	0.33	1	1	1.5	3	FJ946A	208	B	120	A	28 (711.2) High	S
	1	1	2	3	3	7	FJ946B	240	C	208	B		
	3	3	5	7.5	7.5	15	FJ946C	380	D	240	C		
	7.5	7.5	10	10	10	30	FJ946D	480	E	380	D		
575						FJ946E	575	F	480	F			
10	15	25	25	25	50	FJ946E	208	B	120	A	28 (711.2) High	S	
							240	C	208	B			
							380	D	240	C			
							480	E	380	D			
							575	F	480	E			
									575	F			
25	30	50	50	50	100	FJ946H	208	B	120	A	37-1/3 (948.3) High	S	
							240	C	208	B			
							380	D	240	C			
							480	E	380	D			
							575	F	480	E			
									575	F			
40	50	75	100	100	150	FJ946L	208	B	120	A	37-1/3 (948.3) High	S	
							240	C	208	B			
							380	D	240	C			
							480	E	380	D			
							575	F	480	E			
									575	F			

① For constant horsepower instead of constant/variable torque, see Option SV6 on Page 12.

11-300 Replacement Starter Units

IT06 — Intelligent Technologies *IT*. Solid-State Reduced Voltage Starter — HMCP

The *IT*. solid-state reduced voltage starter uses SCRs when starting and a low impedance run circuit during operation. Solid-state starters have (5) 24V DC inputs and 2 relay outputs. Soft start units include a disconnect, starter, 24V DC power supply and 100VA CPT.

Motor Service Factor (SF) Effect on *IT*. Starter Selection

- A 1.0 service factor motor may draw up to 1.00 x full load amperes.
- A 1.15 service factor motor may draw up to 1.15 x full load amperes.
- 15% more current. *IT*. starters are current rated devices. In some cases, a larger *IT*. SSRV starter must be supplied for 1.15 SF motors. See the maximum horsepower chart below.

Note: Most motors used in industrial applications are 1.15 Service Factor (SF).

Table 8. Replacement *IT*. Soft Start Units

Service Factor	Horsepower	<i>IT</i> . Soft-Start Amperes	HMCP Amperes	Catalog Code	Service Voltage	Catalog Code	Control Voltage	Catalog Code	Space Options Inches (mm)	Catalog Code
1.15	20	37	150	FJ306A	480	E	120	A	18-2/3 (474.0) High	S
	40	66		FJ306B			208	B		
	60	105	250	FJ306C			240	C	28 (711.2) High	
	75	135		FJ306D			380	D		
	125	180	400	FJ306E			480	E	37-1/3 (948.2) High	
	150	240		FJ306F			575	F		
	200	304		FJ306G			—	—		

Table 9. Full Voltage 2 Speed 2 Winding — Constant/Variable Torque — HMCP ①

NEMA Size	Maximum Horsepower					HMCP Size	Catalog Code	Service Voltage	Catalog Code	Control Voltage	Catalog Code	Space Options Inches (mm)	Catalog Code
	208V	240V	380V	480V	600V								
1	0.5	0.33	1	1	1.5	3	FJ956A	208	B	120	A	18-2/3 (474.1) High 24 (609.6) High	S X
	1	1	2	3	3	7	FJ956B	240	C	208	B		
	3	3	5	7.5	7.5	15	FJ956C	380	D	240	C		
	7.5	7.5	10	10	10	30	FJ956D	480	E	380	D		
								575	F	480	E		
2	10	15	25	25	25	50	FJ956E	208	B C D E F	120	A B C D E F	18-2/3 (474.1) High	C
								240		208			
								380		240			
								480		380			
								575		480			
3	25	30	50	50	50	100	FJ956H	208	B C D E F	120	A B C D E F	28 (711.2) High	S
								240		208			
								380		240			
								480		380			
								575		480			
4	40	50	75	100	100	150	FJ956L	208	B C D E F	120	A B C D E F	28 (711.2) High	S
								240		208			
								380		240			
								480		380			
								575		480			
5	50	60	100	125	150	250	FJ956P	208	B C D E F	120	A B C D E F	56 (1422.4) High	S
								75		100			
								380		240			
								480		380			
								575		480			

① For constant horsepower instead of constant/variable torque, see Option SV6 on Page 12.

11-300 Replacement Starter Units

Table 10. Full Voltage Non-Reversing — Fusible ①

NEMA Size	Maximum Horsepower					Fuse Clip Amperes	Catalog Code	Service Voltage	Catalog Code	Control Voltage	Catalog Code	Space Options Inches (mm)	Catalog Code
	208V	240V	380V	480V	600V								
1	7.5	7.5	10	10	10	30	FJ204C	208 240 380 480 575	B C D E F	120 208 240 380 480 575	A B C D E F	14 (355.6) High	S
2	— 10	— 15	15 25	15 25	25 —	30 60	FJ204E FJ204F	208 240 380 480 575	B C D E F	120 208 240 380 480 575	A B C D E F	14 (355.6) High	S
3	— 25	20 30	30 50	40 50	50 —	60 100	FJ204H FJ204J	208 240 380 480 575	B C D E F	120 208 240 380 480 575	A B C D E F	28 (711.2) High	S
4	— 50	— 50	— 60	60 100	75 100	100 200	FJ204L FJ204M	208 240 380 480 575	B C D E F	120 208 240 380 480 575	A B C D E F	42 (1066.8) High	S
5	60 100	60 100	100 150	150 200	150 200	200 400	FJ204P FJ204R	208 240 380 480 575	B C D E F	120 208 240 380 480	A B C D E	56 (1422.4) High	S

① Fuse clip ratings shown are based on Class H fuses.

11-300 Unit Options

Table 11. Option Groups ①

Groups	Description	Page Number
A	Advantage Options	10
B	Circuit Breaker Options	10
C	Control Power Source Options	10
G	Ground Fault Protection Options	10
M	Metering Options	11
O	Overload Options	11
P	Pilot Device Options	11
R	Relay and Timer (Control, Voltage, Current) Options	12
S	Starter Contact Options	12
SV	Vacuum Starter Options	12
T	Terminal Block Options	12
U	Unit Wiring Options	12

① Select your option suffix and attach it to the end of the catalog number.

Table 12. Option Suffix

Suffix	Description	Space Required ②
--------	-------------	------------------

A — Advantage Options

A10	Substitute Advantage Starter Size 1	③
A11	Substitute Advantage Starter Size 2	③
A12	Substitute Advantage Starter Size 3	③
A13	Substitute Advantage Starter Size 4	③
A14	Substitute Advantage Starter Size 5	C ③④
A15	Advantage Hand/Off/Auto ACM for FVNR or RVNR Starters	C ④
A16	Advantage Stop/Start for FVNR or RVNR Starters	C ④
A17	Advantage Hand/Off/Auto-Start/Stop ACM for FVNR or RVNR Starters	C ④
A18	Advantage Fast/Slow/Stop 2-Speed Starters	C ④
A19	Advantage Forward/Reverse/Stop for Reversing Starters	C ④
A20	Advantage Fast/Slow/Off/Auto for 2-Speed Starters	C ④
A21	Advantage Forward/Reverse/Off/Auto for Reversing Starters	C ④
A22	ACM Metering Module	C ④
A23	WBELL Form C Bell Alarm Contact	C ④
A24	Reset with Overload Alarm and Trip Indication	C ④
A25	120V AC PLC Circuit Compatible Load Resistor	C ④
A26	WPONI PowerNet Communications Module	C ④
A27	Advantage Status Only ACM	C ④
A28	WPONIDNA DeviceNet Communications Module	C ④

B — Breaker Options

B10	Shunt Trip 120V AC Wired to Terminal Blocks for Remote Tripping	C
B11	Auxiliary Switch Form C (1NO/1NC) Wired to Terminal Blocks	C
B12	Form C Bell Alarm Contact (1NO/1NC) Wired to Terminal Blocks	C
B13	Undervoltage Release	C
B14	IQ Energy Sentinel — F Frame	③
B15	IQ Energy Sentinel — J Frame	③
B16	IQ Energy Sentinel — K Frame	③
B17	IQ Central Energy Display	③
B18	Thermal Magnetic Circuit Breaker Instead of HMCP	—

C — Control Power Source Options

C10	Control Fuse Wired for Separate Source in Lieu of Control Power Transformer	C
C11	Control Fuse with Disconnect for Separate Source in Lieu of Control Power Transformer	C
C12	Control Power Transformer 100 VA for Size 1 and 2 Starters (Fused)	C ④
C13	Control Power Transformer 150 VA for Size 3 and 4 Starters (Fused)	C
C14	Control Power Transformer 100 VA with Interposing Relay for Size 5 Starters, Fused	C
C15	Extra 50 VA for Control Power Transformer	S
C16	Extra 100 VA for Control Power Transformer	S
C17	Service Voltage Control, Fused in Lieu of Control Power Transformer	C
C18	Full Capacity Control Power Transformer for Size 5 Starters, Fused	C

G — Ground Fault Protection Options

G10	Class 1 Ground Fault Protection — GRT1 Size 1 – 4	X
G11	Class 1 Ground Protection — GRT1 Size 5 – 6	X
G12	Ground Fault Test Panel	X

② Minimum unit size required (refer to Replacement Unit pages).

③ Consult factory for spacing.

④ Not available in 9 inches (228.6 mm).

11-300 Unit Options

Table 12. Option Suffix (Continued)

Suffix	Description	Space Required ^①
M — Metering Options		
M10	Mini Voltmeter	C ^②
M11	Mini Ammeter with Current Transformer	S
M12	Mini Elapsed Time Meter	C ^②
M13	Current Transformer for Remote Metering	S
M14	Current Transducer 4-20 mA Output	X
O — Overload Options		
O10	IQ 500 Solid-State Overload Relay	—
O11	IQ 500 Load Protection Module	—
O16	Bell Alarm Contact (1NO) Wired	C
O17	Bi-Metallic Overload Substitution	C
O18	Adjustable A200 Overload Substitution	C
O19	Overload Relay Heater/Heater Pack	C
O20	CEP7 Solid-State Overload Relay	C
P — Pilot Device Options ^③		
P10	Red "RUN" Light	C
P11	Green "STOPPED" Light	C
P12	Amber "OVERLOAD TRIPPED" Light	C
P13	Green "RUN" Light	C
P14	Red "STOPPED" Light	C
P15	Red "RUN" Push-to-Test Light	C
P16	Green "STOPPED" Push-to-Test Light	C
P17	Amber "OVERLOAD TRIPPED" Push-to-Test Light	C
P18	Green "RUN" Push-to-Test Light	C
P19	Red "STOPPED" Push-to-Test Light	C
P20	Special Function Light	C
P30	"START" Pushbutton	C
P31	"STOP" Pushbutton	C
P32	"START/STOP" Pushbutton	C
P33	"ON" Pushbutton	C
P34	"OFF" Pushbutton	C
P35	"ON/OFF" Pushbutton	C
P36	"FORWARD/REVERSE/STOP" Pushbutton	C
P37	"FAST/SLOW/STOP" Pushbutton	C
P38	"FAST/OFF/SLOW" Pushbutton	C
P39	"HIGH/LOW/STOP" Pushbutton	C
P40	"HIGH/LOW/OFF" Pushbutton	C
P41	Special Function Pushbutton	C
P50	"ON-OFF" Selector Switch	C
P51	"HIGH-LOW" Selector Switch	C
P52	"OFF-AUTO" Selector Switch	C
P53	"START-STOP" Selector Switch	C
P54	"SLOW-FAST" Selector Switch	C
P55	"FORWARD-REVERSE" Selector Switch	C
P56	Special Function 2-Position Selector Switch	C
P57	"HAND-OFF-AUTO" Selector Switch	C
P58	"LOCAL-OFF-REMOTE" Selector Switch	C
P59	"FAST-OFF-SLOW" Selector Switch	C
P60	"HIGH-OFF-LOW" Selector Switch	C
P61	Special Function 3-Position Selector Switch	C
P62	"HIGH-LOW-OFF-AUTO" Selector Switch	C
P63	Special Function 4-Position Selector Switch	C

^① Minimum unit size required (refer to Replacement Unit pages).

^② Customer to supply range of meter required.

^③ Available only with F2100, Advantage, Series 2100/5 Star, Freedom Unitrol, F10 Unitrol and Type W. Consult factory for specific size limitations.

11-300 Unit Options

Option Suffix (Continued)

Suffix	Description	Space Required ^①
--------	-------------	-----------------------------

R — Relay and Timer Options

R10	Auxiliary Control Relay 2-Pole (1NO/1NC) Convertible Contacts Wired in Parallel with Starter Coil	S
R11	Auxiliary Control Relay 4-Pole (2NO/2NC) Convertible Contacts Wired in Parallel with Starter Coil	S
R12	Auxiliary Control Relay 2-Pole Overload Alarm (1NO/1NC) Convertible Contacts	S
R13	Mechanical Latching Relay (Specify Connection)	X
R14	Ice Cube Relay 300 Volts 3-Pole Blade Type (Specify Connection)	S
R15	Phase Voltage Relay	X
R16	Current Sensing Relay with Contacts Wired to Terminal Blocks	X
R17	Deceleration Timing Relay (Pneumatic "OFF" Delay)	S
R18	Compelling Timing Relay (Pneumatic "ON" Delay)	S
R19	Time Clock 24 Hour	②
R20	Time Clock 7 Day	②
R21	Solid-State Timer Type TR (Specify Connection)	S
R22	DN65 DeviceNet Interface Module	S
R23	D15 2-Pole Control Relay	C
R24	D15 4-Pole Control Relay	C

S — Starter Contact Options (Maximum of 8 Contacts)

S__	To order extra starter contacts, you must specify the number of NO/NC contacts, given a maximum of eight (8). To define the unit option required, create a suffix based on the following example:							
	<table border="1"> <thead> <tr> <th></th> <th>Quantity of Normally Open Contacts</th> <th>Quantity of Normally Closed Contacts</th> </tr> </thead> <tbody> <tr> <td>S</td> <td>2</td> <td>3</td> </tr> </tbody> </table>		Quantity of Normally Open Contacts	Quantity of Normally Closed Contacts	S	2	3	
	Quantity of Normally Open Contacts	Quantity of Normally Closed Contacts						
S	2	3						

SV — Vacuum Starter Options

SV4	Vacuum Starter Size 4 Substitution FVNR	②
SV5	Vacuum Starter Size 5 Substitution FVNR	②
SV6	Constant Horsepower Instead of Constant/Variable Torque	—

T — Terminal Block Options

T10	Pull-apart Type Terminal Blocks (Standard on all Vintages Except Type W and 11-300)	S
T11	Utility Screw Type Terminal Blocks (Add 6 Inches (152.4 mm) for Every 18 Points)	—
T12	Front-mounted Pull-apart Terminal Block for F2100, Advantage, Series 2100/5 Star	S
T13	T-Lead Power Terminal Blocks for Size 1 Starter	—

U — Unit Wiring Options

U10	Surge Suppressor on Coil	C
U11	Type SIS Control Wire	C
U12	Type SIS Power Wire	C
U13	Type 14 Gauge Control Wire (Standard for all Vintages Except F2100, Series 2100/5 Star, Type W and 11-300)	C
U14	Wiremarkers — Sleeve Type on all Control Wire	C
U15	Locking Fork Terminals on all Control Wiring	S
U16	Ring Wire Terminals on Power Wiring	S
U17	Wiring Diagram Inside Starter Unit Door	C
U18	Pre-insulated Ring Terminals on all Control Wiring	C
U19	Pre-insulated Ring Terminals on all Control Wiring, except for Freedom Starter Terminals	C
U20	Wiremarkers for Power Wiring	C

① Minimum unit size required (refer to Replacement Unit pages).

② Consult factory for spacing.

11-300 Structure and Unit Parts

11-300 Line-up



11-300 Line-up

Handle Mechanism

For 11-300 handle mechanism replacement, see October 2002, *YES Catalog*, Page 2-81.

Blank Unit Door



Blank Unit Door

Table 13. Blank Unit Door

Dimensions in Inches (mm)		Style Number
Height	Width	
4-2/3 (118.6)	20 (508.0)	112D177H15
9-1/3 (237.0)	20 (508.0)	6264A90G01
14 (355.6)	20 (508.0)	6264A91G01

11-300 Starter Unit



11-300 Starter Unit

Unit Guide Rail with Mounting Hardware



Unit Guide Rail with Mounting Hardware

Figure 1. Unit Guide Rail with Mounting Hardware

Description	Style Number
Unit Guide Rail with Mounting Hardware	4719A95G02

How to Create a Catalog Number

After selecting the circuit device required, create a Dual Mounted feeder unit catalog number based on the following:

Note: Catalog number varies in length based on single or dual mounted unit.

Table 14. Catalog Numbering System Example

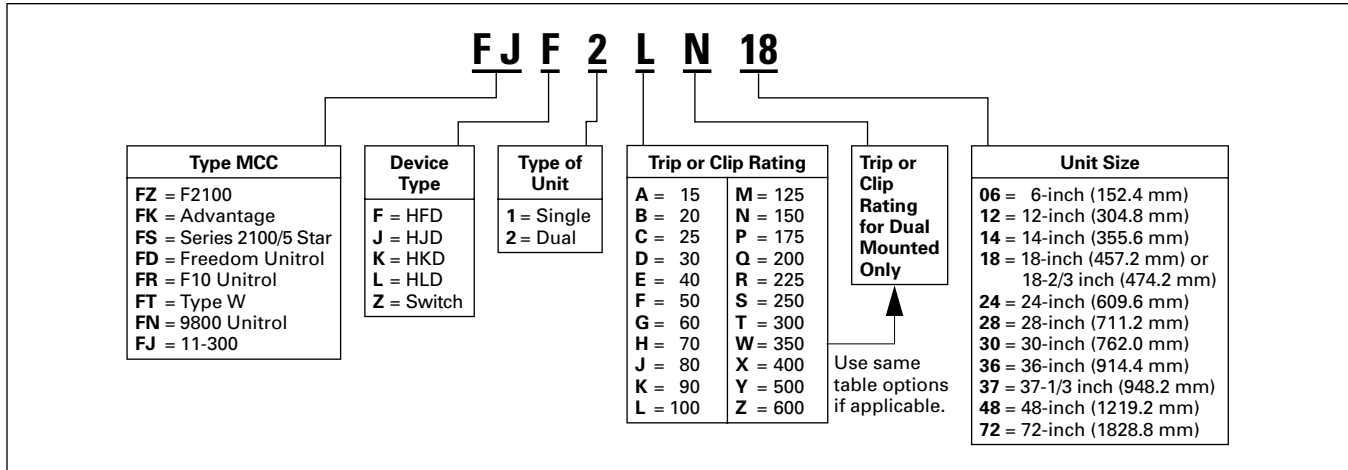

NEMA is the registered trademark and service mark of the National Electrical Manufacturers Association. UL is a registered trademark of Underwriters Laboratories Inc.

Replacement Feeder Units

Product Description

Each Feeder Unit consists of a single-mounted 3-pole molded case circuit breaker or fusible switch (dual mounted are also available). Each unit includes a new wrapper, stab assembly, door, handle mechanism and customer specific disconnect device. They are shipped assembled and ready to install into the existing motor control center.

The following are simple steps to select and order a new feeder unit:

Step 1

Select the circuit device required from **Table 15** below.

Step 2

Verify the amount of space available.

Step 3

Create a catalog number using **Table 14** on **Page 14**.

Unit options and modifications for replacement feeder units:

For factory installed molded case circuit breaker modifications or additional unit options, contact the factory for prices and availability.

Table 15. Electrical Characteristics and Space Requirements of Molded Case Circuit Breakers and Fusible Switch Replacement Feeder Units — Inches (mm)

Device Type	Maximum Amperes	Interrupting Rating (kAIC)			Trip Rating or Clip	Freedom 2100 Series 2100/5 Star Advantage		Freedom Unitrol		F10		Type W		9800		11-300				
		240V	480V	600V		Single	Dual	Single	Dual ^①	Single	Dual ^①	Single	Dual	Single	Dual ^①	Single	Dual			
HFD	150	100	65	25	15															
					20															
					25															
					30															
					40															
					50															
					60															
					70															
					80	6 ^② (152.4)		6 ^② (152.4)						9 (228.6)						
					90	12 ^③ (304.8)	12 (304.8)	12 (304.8)	12 (304.8)	12 ^③ (304.8)	12 (304.8)	12 ^③ (304.8)	12 (304.8)	14 (355.6)	14 (355.6)	14 (355.6)	14 (355.6)			
					100															
					125	12 (304.8)	12 (304.8)	12 (304.8)	18 (457.2)	12 (304.8)	18 (457.2)	12 (304.8)	12 (304.8)	14 (355.6)	18 (457.2)	14 (355.6)	14 (355.6)			
					150	12 ^③ (304.8)						12 ^③ (304.8)		9 (228.6)						
HJD	250	100	65	25	175															
					200															
					225	18 (457.2)		24 (609.6)		18 (457.2)		18 (457.2)		18 (457.2)		14 (355.6)		14 (355.6)		
				250																
HKD	400	100	65	35	300															
					350															
					400	24 (609.6)		24 ^④ (609.6)		24 ^④ (609.6)		24 (609.6)		28 ^④ (711.2)		14 (355.6)				
HLD	600	100	65	35	500															
					600	24 (609.6)		24 ^④ (609.6)		24 ^④ (609.6)										
Fusible Switch	30	100	100	100	30	12 (304.8)	12 ^③ (304.8)	12 (304.8)	18 (457.2)	12 (304.8)	18 (457.2)	12 (304.8)	12 ^③ (304.8)	14 (355.6)	18 (457.2)	14 (355.6)	14 (355.6)			
	60	100	100	100	60	12 (304.8)	12 ^③ (304.8)	12 (304.8)	18 (457.2)	18 (457.2)	18 (457.2)	12 (304.8)	12 ^③ (304.8)	14 (355.6)	18 (457.2)	14 (355.6)	14 (355.6)			
	100	100	100	100	100	18 (457.2)		18 (457.2)		18 (457.2)		12 ^③ (304.8)		18 (457.2)		18 (457.2)	18-2/3 (474.2)			
	200	100	100	100	200	36 (914.4)		30 (762.0)		30 (762.0)		24 (609.6)		28 (711.2)		28 (711.2)				
	400	100	100	100	400	36 (914.4)		72 ^④ (1828.8)		48 ^④ (1219.2)		42 (1066.8)		42 ^④ (1066.8)		42 (1066.8)				
	600	100	100	100	600	48 (1219.2)		72 ^④ (1828.8)												

① Combined ampacity no greater than 150A for 12-inch (304.8 mm) height. For greater than 150A, 18-inch (457.2 mm) required.

② 100A maximum.

③ Available in 18-inch (457.2 mm) height.

④ Cable in/cable out, no stab assembly.

Eaton Corporation
Cutler-Hammer business unit
1000 Cherrington Parkway
Moon Township, PA 15108-4312
USA
tel: 1-800-525-2000
www.cutler-hammer.eaton.com

